



**SCADAfence**

GLOBAL VAD

The Most Comprehensive  
**OT & IoT Security**  
Platform in the World

OTD BİLİŞİM – Eray ATLAS

June, 2022



**OTD BİLİŞİM**

# OT & IoT Cybersecurity Leadership

SCADAfence secures all of your unmanaged OT & IoT devices by providing visibility, risk reduction and compliance, as well as detection & response capabilities.



## NOTABLE IMPLEMENTATIONS

- Europe's largest manufacturing site
- US based fortune 100 O&G enterprise
- One of Japan's largest BMS operators



## AWARDS & RECOGNITION



Highest detection rates & lowest false positives – CPS Security 2020



Entrepreneurial Company of the Year – Frost & Sullivan 2021



Best SCADA Security Solution – SC Magazine 2021



Founding Members of the OT Cyber Security Alliance

- USA region
- Europe
- East Asia
- Middle Asia
- Middle East



## GLOBAL OFFICES

# Industry Awards

	<p>Highest detection rates &amp; lowest false positives</p> <p>– <i>Gartner 2020</i></p>
	<p>Entrepreneurial Company of the Year</p> <p>– <i>Frost &amp; Sullivan 2021</i></p>
	<p>Market Leader in Cybersecurity for Manufacturing</p> <p>– <i>ISG 2020 &amp; 2021</i></p>
	<p>Best SCADA Security Solution</p> <p>– <i>SC Magazine 2021</i></p>



ICS / SCADA Security Market Leader



Security Governance, Risk and Compliance (GRC) Market Leader



Internet of Things (IoT) Hot Company



COMPLIANCE SOFTWARE SOLUTION PROVIDER OF THE YEAR



SCADAfence Next Gen Critical Infrastructure Protection



SCADAfence Cutting Edge Compliance



SCADAfence Cutting Edge ICS / SCADA Security



TSR The Investor's Report



# Notable Customers

**ENTERPRISE DEPLOYMENTS: 6 CONTINENTS, 12 VERTICALS**



## Oil & Gas

CHS Inc. is a Fortune 100 business, as America's largest cooperative refiner, CHS meets your fuel needs by maximizing diesel production at its refineries.



## Process Manufacturing & Transportation

T6 is one of the largest private ports in LATAM and one of the largest producer of grain extracts. With daily processing of 76,000 tons of goods.



## Building Management Systems

Mitsui Fudosan is largest and leading real estate developer in Japan and their business expands worldwide, to the US, UK, China, Singapore, Thailand & Malaysia



## Discrete Manufacturing

Vestel is a Turkish home and professional appliances manufacturing company consisting of 18 companies specialized in electronics, major appliances and information technology.



## Process Manufacturing

Taro is a research-based pharmaceutical manufacturer publicly listed in the New York Stock Exchange. The company has more than 180 of its own drugs sold all over 25 countries



## Metal & Plastics

Headquartered in Germany, EOS is the leading technology provider worldwide for industrial 3D printing of metals and plastics.



# Industries Served

---



MANUFACTURING



CRITICAL INFRASTRUCTURE



FACILITIES



UTILITIES



OIL & GAS

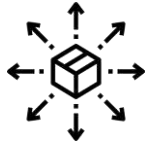

LOGISTICS



MINING



WATER



CHEMICALS



PHARMA



AUTO



FOOD & BEVERAGE

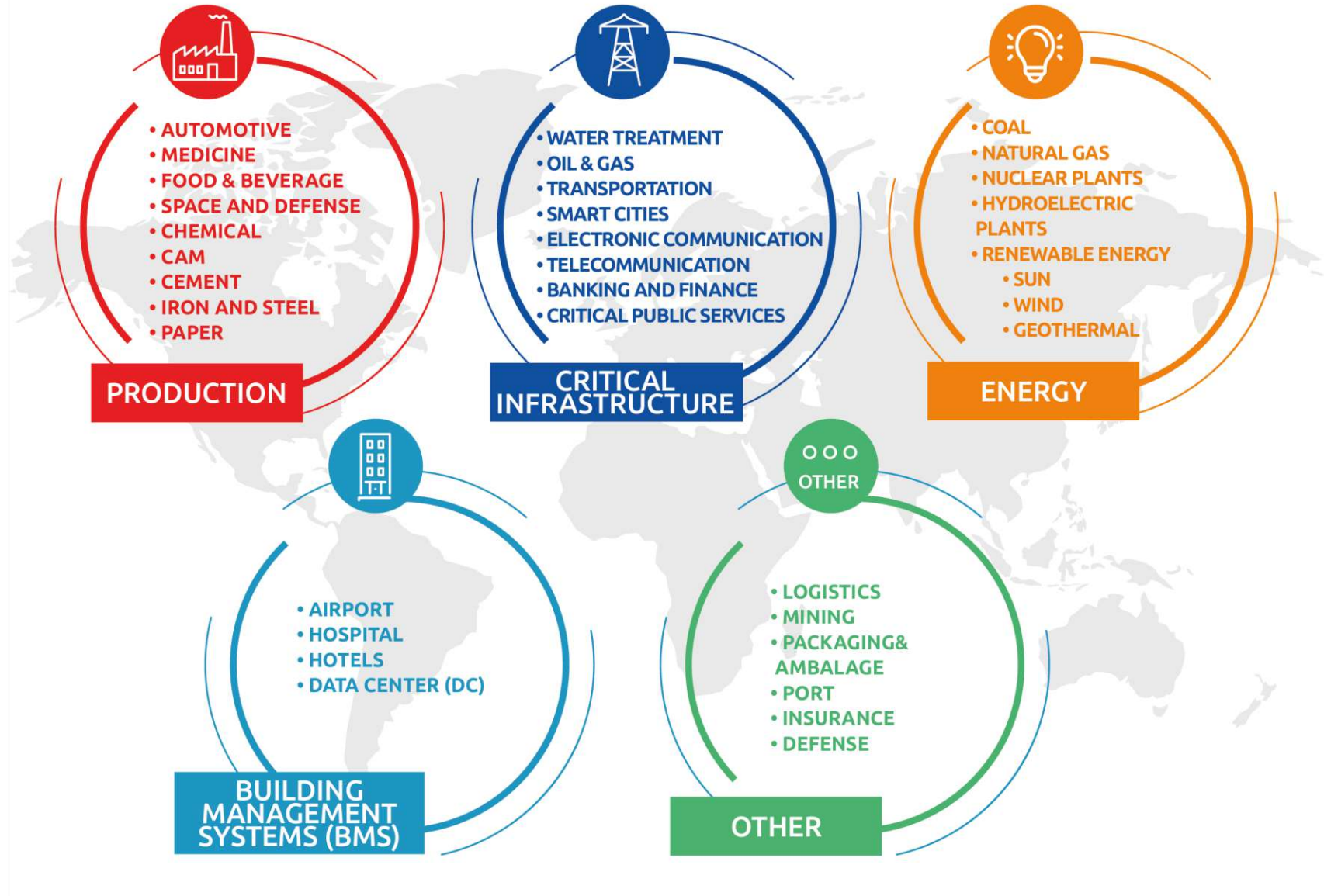

# The SCADAfence Product Suite

## Broad Coverage of OT & IoT Asset Management, Governance and Security Products



### The SCADAfence Platform

- **Visibility** – Full visibility into OT & IoT networks and communication patterns, exposing potential attack vectors and improving network security hygiene.
- **Asset Management** – Fully automated asset discovery and inventory.
- **Risk Reduction** – Reduce risk without changes to the network or infrastructure.
- **Real-time Detection** – Passively detects indicators of compromise in real-time and provides early indications of an attack.
- **Immediate Response** – Seamlessly integrate with existing security controls and SecOps procedures.



### The SCADAfence Governance Portal

- **Central Governance** – Continually monitors remote sites for adherence to industry standards and organizational policies.
- **Industry Standards** – Covers common industry standards including IEC62443, NIST, NERC CIP, ISO27001 and others.
- **Reporting** – Automatically generate compliance reports for onsite and executive teams.
- **Cost Reduction** – Centralized management of remote sites reduces travel and onsite audit costs.



### SCADAfence IoT Security

- **Policy Enforcement** – Enforce the organization's policies and reduce risk with early detection of changes on IoT devices that may compromise the network.
- **Central Orchestration** – Centrally orchestrate configuration changes and perform bulk actions on IoT devices of all types.
- **Threat Detection** – Detect and automatically respond to cyber threats targeting IoT devices or originating from IoT devices.
- **Agentless Deployment** – Simple onboarding and maintenance with an agentless deployment.

# The SCADAfence Platform

The Top-Rated OT & IoT Security Solution  
On Gartner's Peer Insights

Find Out Why

---



SCADAfence is the  
highest rated vendor  
in the Operational  
Technology Security category



Willingness to recommend  
**100%**



# OT/IoT Security – A New Form of IT Security Challenge

## Digitalization is Here - OT and IT Infrastructure Have Converged

- Traditional air-gapped OT devices increasingly rely on internet/IT connection to drive efficiency and lower costs
- Connected OT devices, commonly unpatched and unprotected, significantly expand the attack surface, with a potentially catastrophic result if breached.

## OT / IoT Devices are Typically Unmanaged

- Traditional asset management solutions are unable to detect OT / IoT devices on the network
- Unmanaged devices leave the network vulnerable to breaches and are not accounted for in planning and incident response.

## Traditional Security Control Cannot Secure OT & IoT Devices

- Traditional patch management, end point protection and firewalls cannot secure OT and IoT assets.
- OT / IoT assets can not run agents and often use unsecured communication protocols which are extremely vulnerable to attacks

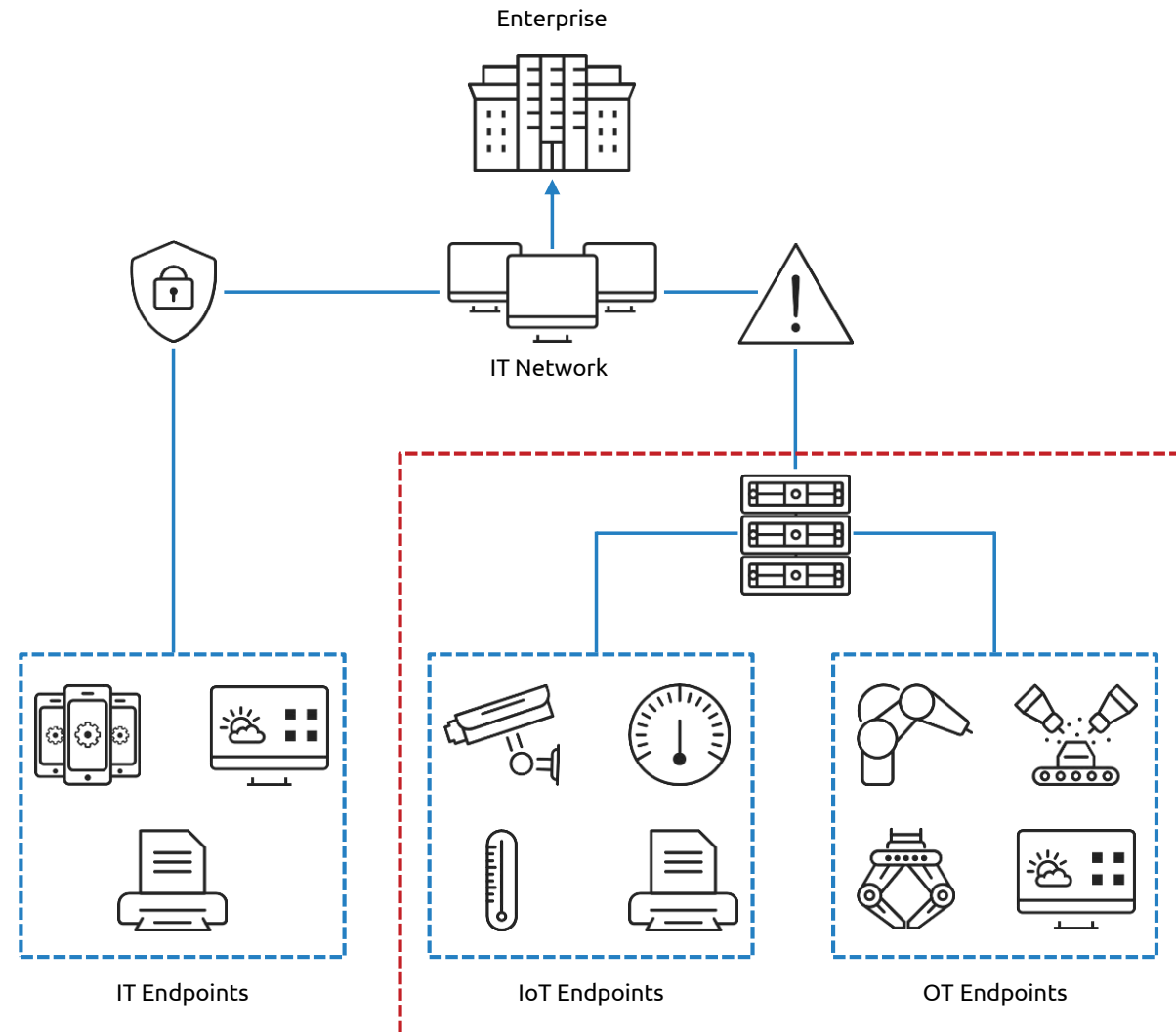

# The SCADAfence Platform Provides:

---



## VISIBILITY

Get full visibility into OT & IoT networks including asset details, communication patterns and insights into vulnerabilities and exposure.



## ASSET MANAGEMENT

Get an automated, accurate, and real time asset inventory.



## RISK REDUCTION

Immediately reduce your risk, without changing your existing network or infrastructure by exposing potential attack vectors and by improving your network security hygiene.



## DETECT THREATS IN REAL-TIME

Passively detect indicators of compromise in real-time, and get early indications of an attack throughout the cyber kill chain.



## IMMEDIATE RESPONSE

Respond immediately to threats by seamlessly integrating with existing security controls and SecOps procedures.

# The SCADAfence Platform is Built Different

---

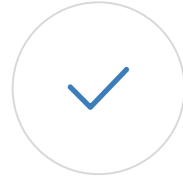

## ADVANCED SECURITY ENGINES

- Highest detection rate with 100% traffic DPI.
- Micro-granular baseline with minimal false positives.
- OT protocols AI clustering & anomaly detection.

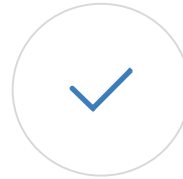

## HIGHEST USABILITY

- Minimal configuration required, auto-tuning baseline.
- Clear alerts and alert handling process.
- Maps, rules and interfaces customizable to fit user's OT environment.
- Track user activity and value level changes.

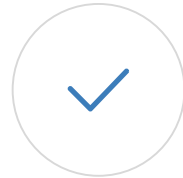

## ASSET INVENTORY MANAGEMENT

- Detailed inventory discovery, including WMI views.
- Customizable asset maps models.
- Automatic profile based anomaly detection.

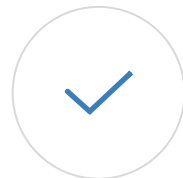

## LOWEST TCO

- Distributed deployment NetFlow technology.
- Manage 10Ks of assets from one platform.

# Flexible Deployment Options

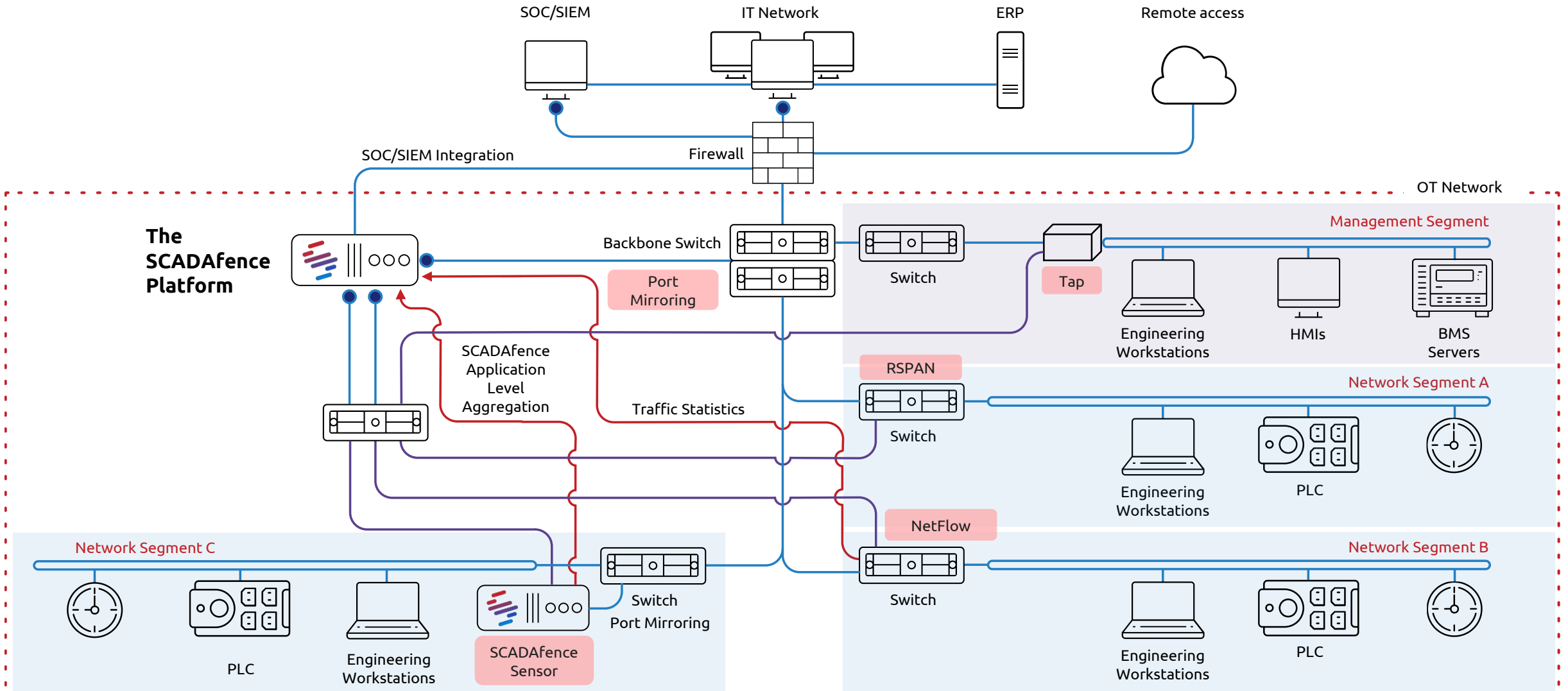

# The SCADAfence Governance Portal

## IT/OT Governance Done Right

---

# IT/OT Governance Done Right

---



## ✓ CENTRAL GOVERNANCE

Continuously monitor your remote sites' adherence to industry standards (IEC 62443, NERC CIP, NIST, ISO 27001 and others) and organizational policies.

## ✓ ALWAYS UP TO DATE

The SCADAfence Governance Portal is based on real time data extracted from the networks, providing continuous, real time visibility to the adherence of regulations and industry frameworks.

## ✓ IMPROVEMENT OVER TIME

Track improvement of organizational compliance over time.

## ✓ REPORTING

Automatically generate compliance reports to the executive team and the onsite teams for following up on open items.

## ✓ REDUCE COSTS

By centrally managing the governance of your organization's remote sites, you'll eliminate the need for travel and onsite audits.

# The Unique Advantages of the Governance Portal

---

- ✓ We are the only vendor that offers this.
- ✓ 24/7 continuous visibility into compliance status.
- ✓ Reduces manual audit work.
- ✓ User customizable – add organizational policies.
- ✓ Organizational dashboard – collect events from 3<sup>rd</sup> party products.
- ✓ Based on real traffic, not on offline assessments.

# We Integrate With Your Existing Tools

---







## INTEGRATION OPTIONS

-  REST API and Syslog
-  System Customization

## INTEGRATION USE CASES

-  Enforcement & Remediation
-  Incident Response and Management
-  Enrichment of Data

## EXISTING SECURITY CONTROLS

-  Firewall
-  Gateway
-  SIEM
-  SOAR
-  NAC
-  CMDB
-  Remote Access



# SCADAfence Provides You With

---

- ✓ The best security coverage: 100% inspection, adaptive, device based baseline.
- ✓ The lowest false positives in the industry.
- ✓ The most efficient TCO for large distributed deployments.
- ✓ The quickest deployment time, no tuning and baseline restarts, no baseline downtime!
- ✓ The ability to track (remote) user activity with no additional add-ons.
- ✓ The ability to centrally manage governance of remote sites (IEC 62443, NERC CIP, NIST and others).
- ✓ Highly customizable maps, models, standards and policies, & asset DB (for enterprises).
- ✓ The most advanced IoT support with policy enforcement and central configuration management.

# What Our Customers Are Saying

---

”

*“SCADAfence enhances our ability to continue and adopt Smart City technologies, and will allow us to operate securely as we digitalize our OT infrastructure.”*

***Akira Sugawara, General Manager***



”

*“With SCADAfence, we feel secure while we bring our production environment into the Industrial IoT era.”*

***Itzik Baruch, VP Technical Services***



”

*“By integrating SCADAfence into our environment, we were finally able to add OT visibility and monitoring to our ongoing security operations.”*

***Halil Aydın IT infrastructure and Operations Director***



# What Industry Experts Are Saying

---

”

*“Increase detection accuracy and decreased false positives, are further reduced by the automated Micro Granular Baseline technology and by automated noise cancellation. SCADAfence’s self-tuning baseline minimizes false positives; this means that no user configuration is required, nor is any stop-and-restart needed to relearn. This system allows for a scalable solution for a huge organization and seamless integration with OT networks.*

***Wam Voster, Senior Director Analyst***



”

*The threat detection capabilities of SCADAfence's real-time traffic monitoring will stand out as a key capability for the company, especially when compared to other OT cybersecurity vendors.*

***Global Cyber Security Research Team at Frost & Sullivan***



”

*Internal interactions with governing bodies in OT cybersecurity for governments and manufacturing facilities give SCADAfence a competitive advantage over other players in this space.*

***Avimanyu Basu, Chief Analyst***



# Sample Case Studies

---

**VESTEL**

# Case Study

## Organization

- Vestel City – Europe’s largest manufacturing facility
- Producing 20 major product categories
- 1,100,000m2 closed production area
- 35 million device production capacity

## Industry

- Manufacturing
  - Electronics
  - Major appliances
  - Information Technology

## Solutions Deployed

- The SCADAfence Platform

## Challenges

- New technologies for automation and increased productivity increase exposure to potential attacks
- Large-scale, complex, and dynamic environment with limited network visibility
- IT / OT convergence and remote access
- Lack of forensics and incident response capabilities in OT

## Why SCADAfence?

- Immediate risk reduction from day 1 – detection of risks and threats
- Full support for large-scale and complex activities, featuring a responsive UI and actionable alerts
- Monitoring tens of thousands of OT devices at minimal TCO
- Seamless integration with existing IT security operations and tool

## Key Benefits



Complete visibility into network architecture and day-to-day activities



Ongoing monitoring of exposure to risks, and predictive warnings



Continuous threat detection of malicious and other abnormal activities



*“SCADAfence’s performance in large-scale networks and detection capabilities are unlike any other platform in the industry.”*

***Murat Akin, OT Network Engineer, Vestel***



# Case Study

## Organization

- International pharmaceutical company with more than \$4B revenue
- Produce more than 180 drugs in 25 countries
- Hundreds of industrial devices and complex network structures across seven production floors

## Industry

- Pharmaceutical / Process Manufacturing
- Manufacturing facility produces chemical-based active pharmaceutical ingredients (APIs)

## Solutions Deployed

- The SCADAfence Platform

## Challenges

- Security of OT networks due to increased connectivity and complexity due to regulatory requirements and adoption of advanced technology
- Overcome the lack of visibility into network activities from outside contractors and remote maintenance traffic
- Maintain leading positions in a competitive market despite strict FDA regulations that require full control over Manufacturing Operations

## Why SCADAfence?

- Complete visibility of network architecture – assets, connections & traffic
- Compliance with accurate asset inventory and regulations & accelerates new technology adoption
- OT network anomaly detection - identifies malicious activities and operational errors
- Continuous threat detection of malicious and other anomalous activities

## Key Benefits



Full Visibility



Vulnerability Management



Real-time Threat Detection



Policy Management

“ Along with regulatory demands such as Track and Trace systems, our dynamic and advanced production environment required a significant improvement in our security capabilities. With SCADAfence, we feel safe as we move our production environment into the Industrial IoT era.

**Itzik Baruch, VP Technical Services, Tarco.**

# Case Study

## Organization

- Hutchinson – Reno, The largest city in Kansas. Serving 42,080 people
- Treats 5 million gallons of wastewater per day
- Facilities: RO Water treatment Center, 20 water wells, 2 booster pump stations, 4 water storage towers, 2 waste wells, multiple groundwater remediation facilities

**Industry** - Water / Wastewater

**Sector** – Critical Infrastructure

## Solution Applied

- SCADAfence Platform

## Challenges

- Centrally manage water and wastewater assets distributed across the city
- Visibility in OT networks to look for vulnerabilities
- Identify whether any intruder is trying to get access to OT / SCADA networks
- Monitor potential threats to SCADA networks and industrial control systems

## Why SCADAfence?

- Central management of all water and wastewater assets in the city
- Full visibility into SCADA & OT networks • Detailed asset monitoring, remote access security and continuous threat detection
- Significant risk reduction from day 1
- Ensures the security of water and wastewater treatment services for the entire city

## Key Benefits



Full visibility into the OT/SCADA network and remote events



Continuous monitoring of exposure to risks and threat detection



Centralized management of all facilities and assets of the city

“ Without SCADAfence, we wouldn't have known about these remote access connections, as we thought we had our firewalls set up correctly. But SCADAfence was able to bring that traffic to the surface and then helped us keep the intruders out.

**Jeff Roberson, Network Administrator for the City of Hutchinson, Kansas**



# Case Study

## Organization

- One of the largest private ports in Latin America
- Daily reception of 76,000 tons of products
- Milling capacity of 20,000+ tons/day
- Over 1.3 million tons shipped

## Industry

- Industrial production
  - Crude oil
  - Protein meal shell pellets
  - Refined glycerin

## Solutions Deployed

- The SCADAfence Platform

## Challenges

- New technologies for plant automation systems increase exposure to potential attacks
- IT/OT convergence, remote access, and policy enforcement capabilities
- Lack of forensics and incident response capabilities in OT
- Governance and policy management tools
- Automated vulnerability assessment

## Why SCADAfence?

- Immediate risk reduction – real time threat detection
- Full visibility – asset & network monitoring across all production sites & refineries
- Vulnerability Management – for embedded and windows devices
- Governance & Compliance – policy management and compliance for all sites

## Key Benefits



Full Visibility



Vulnerability  
Management



Real-time  
Threat  
Detection



Policy  
Management

“We were surprised at how valuable it is to have real-time accurate information about our security posture. The SCADAfence Platform extends the power of security engineers, and aligns our entire organization under the same policies and best practices.”

**Rodrigo Diaz, Supervisor of Infrastructure Systems at Terminal 6**





# Thank You

---

**Contact:**

+90 (216) 912 10 05

[otd.salesgrp@onlineteknikdestek.com](mailto:otd.salesgrp@onlineteknikdestek.com)